



PHOTOELECTRIC BEAM DETECTOR

INSTALLATION INSTRUCTIONS

XA-030D (30m)

XA-060D (60m)

XA-080D (80m)

XA-100D (100m)

! Note: Please read instructions completely beginning installation.

1. This unit designed to be incorporated into an overall alarm system. As it is part of the system ALEPH cannot assume responsibility for theft or damage if the system fails to operate.
2. ALEPH reserves the right to change specification and design without period noticed as parts of its continuing program of product improvement.
3. A walk test of the units detector function must be performed at least once per year.
4. ALEPH suggest use within the precaution range of 10m to 30/60/80/100m about this product, please set up the Turn down plate in front of lens on transmitter for stability improvement if install within 10m. (See Manual PAE-0231A attached for more detail)

1. Parts identification

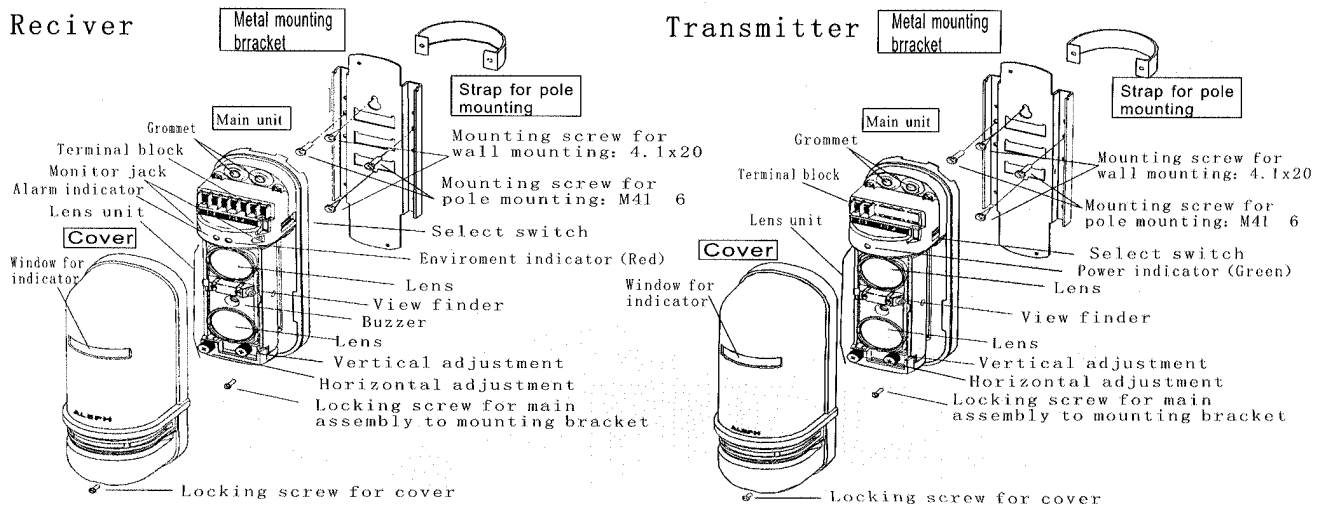

2. Coverage and adjustable range

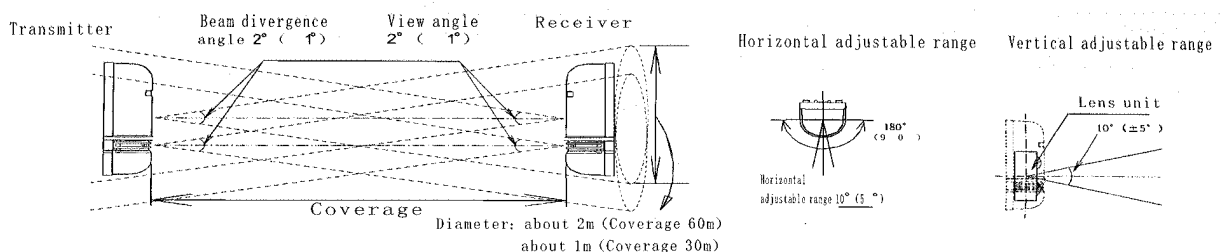

3. Installation Hints

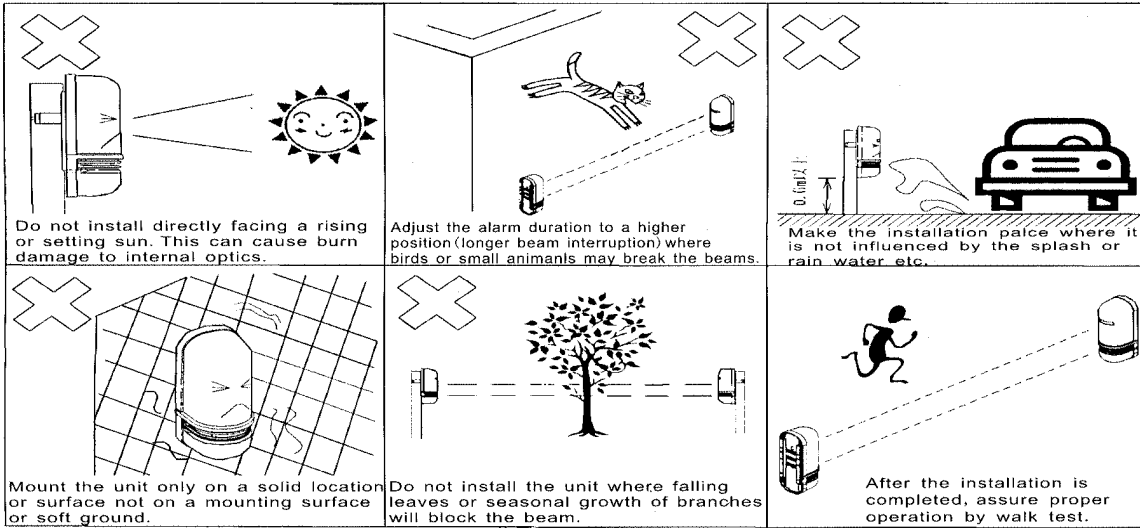

4. How to select a mounting location

Wall mount

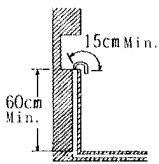

Pole mount

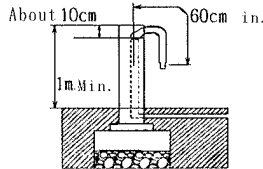

When installing units, check the strength of the wall pole.

1) Wall mount

- Install an electrical box 0.6m (23.6in.) from the floor or ground.
- Use 0.15m (5.9in.) wire for installation (at box).
- When using the wall, bury the wiring or use conduit.

Install the wiring box at least 0.1m (3.9in.) under the cover case.

- Installation height should be 0.6m (23.6in.) from floor or ground.

2) Pole mount

- The pole mount should be 1m (39.4in.) high.
- Make a hole for the wire about 0.1m (3.9in.) from the top of the pole.
- Use at least 0.6m (23.6in.) of wire from the hole.
- Installation height should be 0.6m (23.6in.) from floor or ground.

For the best results, install the transmitter and receiver face to face. It is recommended to use shielded wire when not using metal conduit, don't use aerial wire.

Use this chart to determine the wire size and maximum wiring distance between the sensor and power source.

Voltage	DC12V		DC24V	
	XA-030D	XA-060D/080D/100D	XA-030D	XA-060D/080D/100D
Φ 0.65 Rigid solid (52 Ω/km)	250m	227m	1750m	1577m
Φ 1.0 Rigid solid (22 Ω/km)	591m	536m	4136m	3727m
AWG16 Flexible stranded (15.6 Ω/km)	813m	756m	5833m	5256m
AWG22 Flexible stranded (62.5 Ω/km)	208m	189m	1456m	1312m

Note: When using more than one pair of units on the same wire run, the values must be divided by the number of units used.

5. Installation

Loosen the locking screw of the cover and detach the cover from the main assembly.

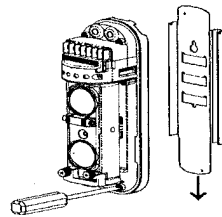
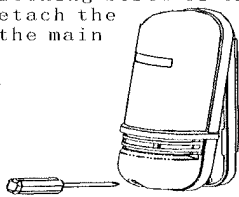

Detach the metal mounting bracket from the main assembly by removing the one retaining screw (M3xL8-SUS). Install the mounting bracket to the wall or pole as below.

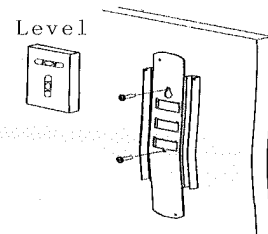
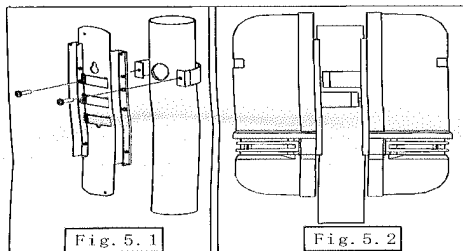

Pole Mount

- It will be mounted in the pole outer diameter $\varnothing 38\text{mm}$ (1.50in.) to $\varnothing 45\text{mm}$ (1.77in.) if screw M14X12 of accessories are used. Please perform mounting as shown in Fig. 5.1. height can be united, if it mounted as shown in Fig. 5.2 and straps to a mounting bracket are mounted in height and low when attaching back to back at one pole.

Wall Mount

- Such as the top picture, attach the wall from metal mounting bracket by rolling two retaining screw (wood screw). Then, it is installed at right angles to the ground (floor).

6. Wiring

Wall mounting and pole mounting should check that the mounting bracket is being fixed firmly, as shown in Fig. 6.1, please install them with a main unit, and let wiring pass between a main unit and mounting bracket. Then, please fix a main unit and mounting bracket by screw. As shown in fig. 6.2, please connect wiring on a terminal block.

When set an alarm output to N. O., please change select switch No. 3 of to ↓ side.

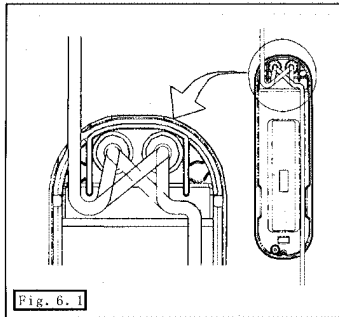
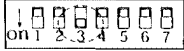

Fig. 6.1

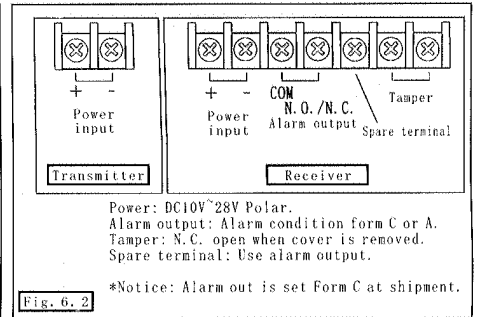
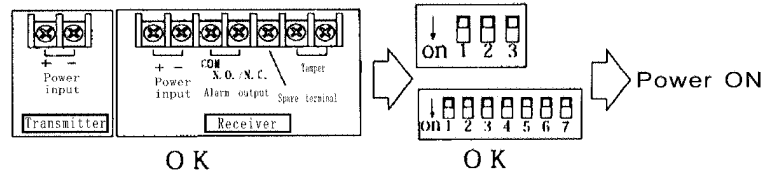

Fig. 6.2

7. Optical Alignment installation

Notice: Since a sensitivity margin changes a lot, please be sure to implement optical alignment adjustment or Transmitter and Receiver according to the level of optical alignment adjustment.



1. Wiring of Transmitter and Receiver being connected correctly and channel setup of selection switch are checked and power is supplied.

2. It moves to right and left with the lower part of the lens unit of a Transmitter, and a lens side is turned in the direction

Transmitter and Receiver

Receiver

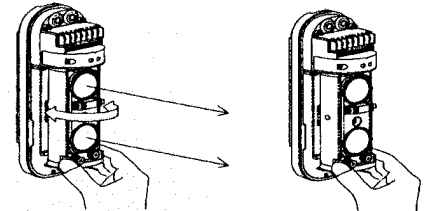

3. Next, it moves to right and left with the lower parts of the lens unit of Transmitter, and a lens side is turned in the direction of Receiver.

4. Furthermore, peeping into view finder of Transmitter, a horizon adjustment knob and a verticality adjustment knob are turned, and it adjusts so that Transmitter may come to the central part.

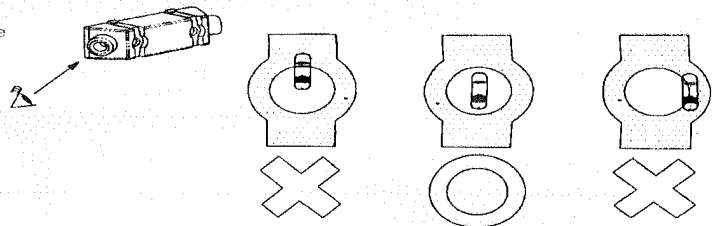

5. Next, peeping into view finder, a horizon adjustment knob are turned, and it adjusts so that Receiver may come to the central part.

6. The maximum sensitivity can be checked also in the state of lighting of environment indicator (Receiver)

Sensitivity	Low <			> High
Environment indicator	ON	Flicker (slow)	Flicker (fast)	OFF

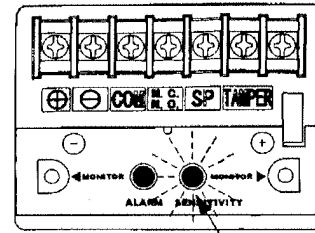

Environment indicator

7. Because furthermore to make it have the sensitivity to spare, make adjustment a horizontal adjustment and a vertical adjustment, under the condition that a VOM tester stick is inserted into the monitor jack on the receiver. Make adjustment so that the voltage of the VOM may become the biggest. After that, with covering the lens of the top a receiver optical vessel and the bottom part in one side each, make adjustment and optical shaft so that there may not be a difference in monitor output voltage of the top and the bottom part.

Notice: Please be advised that the sensitivity falls and the sight adjustment can't be performed if the front portion (Optical alignment) of a lens is interrupted by hand in case adjustment by Monitor Voltage (In additional, if Beam of Transmitter other than for optical alignment is interrupted while installing two or more Beam Detector, more exact optical alignment can be performed without being influenced of other Beam.).

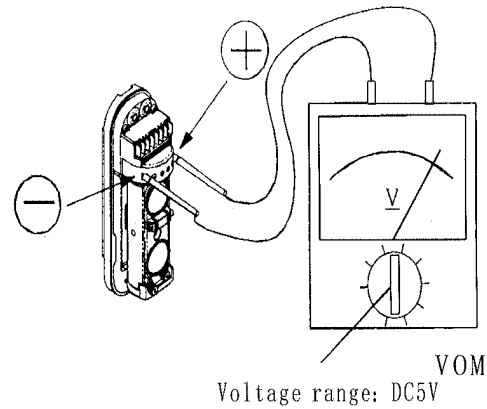

8. If optical alignment finishes, LED is made to turn off by operating select switch No. 3 of Transmitter and No. 4 of Receiver if needed.

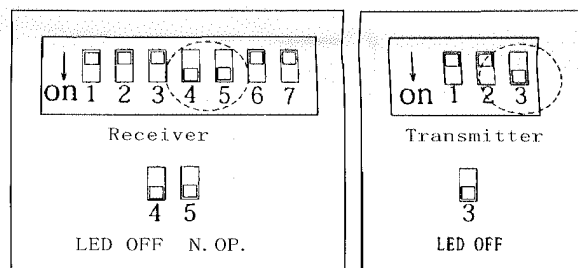

10. Trouble Shooting

Condition	Cause	Installation and Check
Transmitting green LED does not turn on. Alarm Red LED on receiving does not turn on when both beams are interrupted.	No power or insufficient voltage (broken connection power down).	Voltage check (10V DC to 28V DC) check connection
Voltage and switch setting is no problem, but alarm LED does not turn on	A Transmitter or beam reflects in something and is carrying out ON light to Receiver.	Object → Remove Installation place → Change Re-align
Alarm LED on, but no relay output	Signal cable is short circuit	Check cable.
Alarm LED stays on continuously.	Not aligned properly.	Re-align
	Object is blocking beams.	Object → Remove
	Dirty cover.	Clear cover
False alarm during fog. False alarm during rain. False alarm during snow	Poor alignment.	Re-align
False alarm due to small animal, fallen leaves and fallen garbage.	Response time short.	Adjust response time.
	Beam mounted too low.	Installation place → Change.

11. Specifications and Dimension

Items	Specifications	Remarks	
Product Name	Photoelectric Beam Sensor	_____	
Model	XA-030D XA-060D XA-080D XA-100D	_____	
Detection Method	Pulse Code Mark Coincidence From of Infrared Beam	_____	
Coverage	30m 60m 80m 100m	Outdoor	
Adjustable Range	Vertical: 5 ; Horizontal: 9 0	A Transmitter & a Receiver	
Interruption Period	40msec/100msec/400msec/700msec	4 stage by DIP switch	
Supply Voltage	DC10~28V	Concerned with polarities	
consumption current	77mA max 85mA max	Supply Voltage 12V DC Transmitter+Receiver Total	
Alarm output	Conditions	When beam is shaded. When power supply voltage falls	
	Rating	DC30V, 0.3A Photo MOS relay output 1a or 1b (Selectable by switch) Alarm duration: 2 seconds (Min)	Resistive Load Output from alarm terminal that located on the receiver
	Indicator	Red LED on (Alarm Condition)	Located on the receiver. Can not display when power off ON/OFF by DIP switch
Optical Alignment	Voltage level	Insert the Voltmeter's probe into the monitor jack located on the Receiver, and adjust for the Max. voltage	_____
	Alignment LED	Red LED Indicator ON, Flash and OFF is changed by receiver level	Located on the receiver ON/OFF by DIP switch
Tamperswitch	Conditions	N.C. Opens when Receiver's cover is removed	Output from tamper terminal that located on the Receiver
	Rating	DC30V, 0.3A Dry contact relay output	_____
Power Indicator	Green LED on when Transmitter is powered	Located on the transmitter ON/OFF by the switch	
Incidental function	Automatic Gain Control (AGC) function Spare terminal block: 1 piece (located on the receiver)	_____	
Environment	Temperature: -25~+55°C Humidity: Rh. 95% max.	_____	
Dimensions	234 [H] 7 [W] 8 3 [D] [mm]	Cover: black PC resin Main unit: yellow ABS resin	
Weight	Transmitter: 520g Receiver: 550g	Including a mounting bracket	
Accessories	Pole mounting brackets, hook, screws, installation instructions		
Option article	Cover with heater, Pole Cover, Pole		

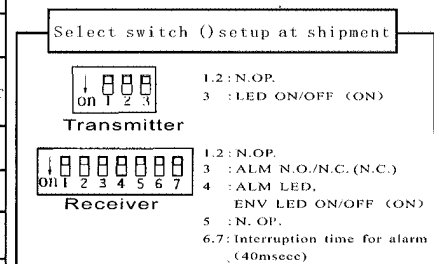
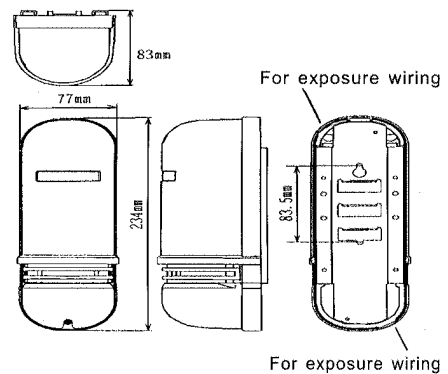

PAE-0396



Manufacturer: ALEPH Electronics (Shenzhen) CO., LTD
 Add: A20 building, Hengfeng industrial city, Hezhou,
 Xixiang town, BaoAn district, ShenZhen, P. R. C
 Tel: (0755) 27325533
 Fax: (0755) 27325779
 http: //www. aleph-cn. com/

Corporation: Nippon ALEPH Corporation
 Add: 1-28-52 Komaoka-cho, Tsurumi-ku, Yokohama, Japan
 Tel: 0081-045-575-1111
 Fax: 0081-045-580-1676
 http: //www. nippon-aleph. co. jp/
 E-mail: security@po. nippon-aleph. co. jp

8. Beam interruption time adjustment

This adjustment is for coping with the environment, variable from 40msec. to 700msec. by using of the selection switch No. 6 and No. 7 of the receiver.

Birds, beside the window or no the wall can occasionally interrupt the beam adjustment, adjust setting according to the alone figure.

In addition a target moving faster than the maximum speed setting will not be detected.

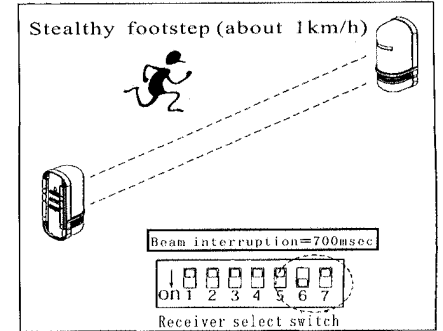
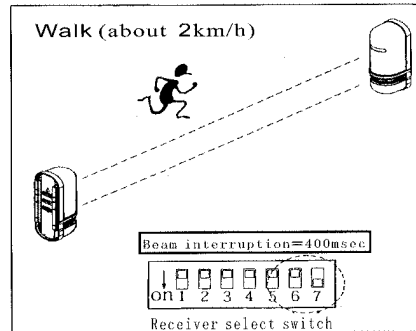
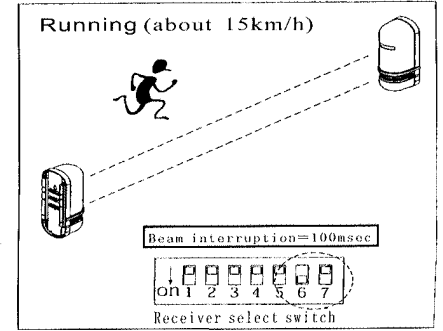
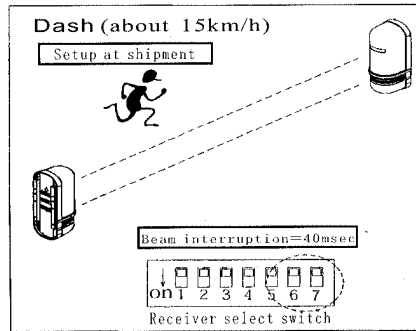

9. Test (Operation Check)

1. After installation, walk-test the unit for proper operation.
2. After installing the cover, start an operation check. Confirm that the tamper switch is closed on both units (Transmitter and Receiver)
3. Since optical alignment may have a change when the environment indicator which was turned off till then lit up after putting a cover, please readjust optical alignment.

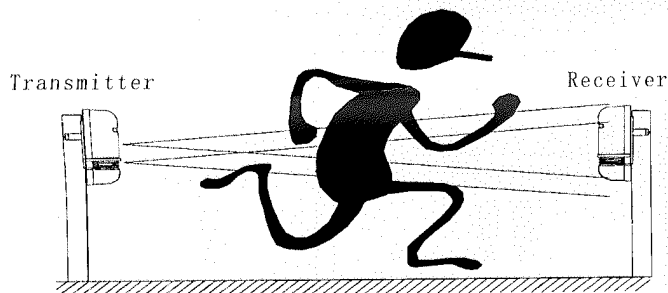
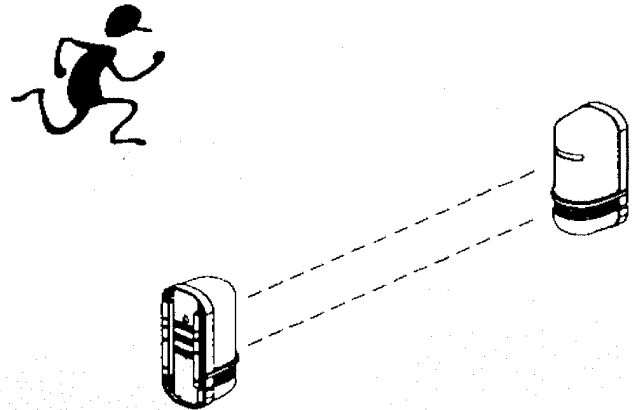

Alarm comes out when the beam of both of upper and lower sides is interrupted.

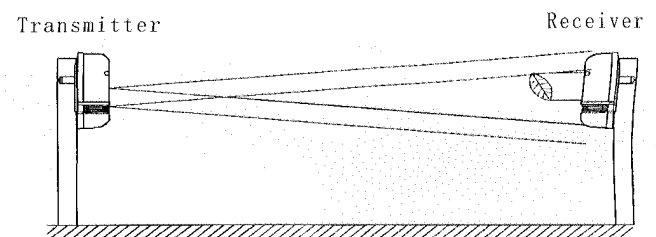

Alarm does not come out, even though interrupt the beam of one of upper and lower sides.